

INNOLUX DISPLAY CORPORATION

LCD MODULE

SPECIFICATION

Customer: _____

Model Name: PT035TN01 V.3

SPEC NO.: P035-01-TT-31

Date: 2006/03/10

Version: 01

Preliminary Specification

Final Specification

For Customer's Acceptance

Approved by	Comment

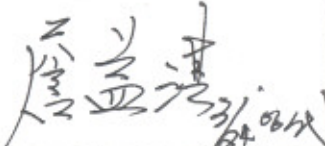
Approved by	Reviewed by	Prepared by
		

Record of Revision

Version	Revise Date	Page	Content
1	2006/3/10		Initial release

Contents:

1. General Specifications	1
2. Pin Assignment	2
3. Operation Specifications	5
3.1. Absolute Maximum Rating	5
3.2. Power Sequence	6
3.3. Electrical Characteristics	7
3.3.1. Typical Operation Conditions	7
3.3.2. Current Consumption	8
3.3.3. Backlight Driving Condition	8
3.4. Timing Characteristics	9
3.4.1. AC Electrical Characteristics	9
3.4.2. Timing Diagram	12
4. Optical Specifications.....	15
5. Reliability Test Items	19
6. Handling Precautions.....	20
6.1. Safety	20
6.2. Handling	20
6.3. Static Electricity	20
6.4. Storage.....	20
6.5. Cleaning	20
7. Mechanical Drawing	21
8. Package Drawing	22
8.1. Packaging Material Table	22
8.2. Packaging Quantity	22
8.3. Packaging Drawing	23

1. General Specifications

No.	Item	Specification	Remark
1	LCD size	3.5" inch	
2	Driver element	a-Si TFT active matrix	
3	Resolution	320X3(RGB)X240	
4	Display mode	Normally White, Transmissive with Micro Reflective	
5	Dot pitch	0.073(W)X0.219(H) mm	
6	Active area	70.08(W)X52.56(H) mm	
7	Module size	78.2(W)X65.0(H)X3.5(D) mm	Note 1
8	Surface treatment	Hard coating	
9	Color arrangement	RGB-stripe	
10	Interface	Digital	
11	Backlight power consumption	0.396W(Typ.)	
12	Panel power consumption	20mW(Typ.)	
13	Weight	35g	

Note 1: Refer to Mechanical Drawing.

2. Pin Assignment

Pin No.	Symbol	I/O	Function	Remark
1	GLED	P	GND for LED	
2	GLED	P	GND for LED	
3	VLED	P	Power for LED	
4	VLED	P	Power for LED	
5	GND	P	Ground	
6	NC	I	No connect	
7	NC	I	No connect	
8	NC	I	No connect	
9	NC	I	No connect	
10	GND	P	Ground	
11	NC	-	No connect	
12	NC	-	No connect	
13	POL	O	Polarity select for the line inversion control signal.	
14	RESET	I	Reset	
15	SPENA	I	Serial port data enable signal. Normally pull high.	
16	SPCK	I	Serial port clock .Normally pull high.	
17	SPDA	I/O	Serial port data input/output.	
18	D00	I	Data 00	Note2
19	D01	I	Data 01	Note2
20	D02	I	Data 02	Note2
21	D03	I	Data 03	Note2
22	D04	I	Data 04	Note2

23	D05	I	Data 05	Note2
24	D06	I	Data 06	Note2
25	D07	I	Data 07	Note2
26	D08	I	Data 08	Note2
27	D09	I	Data 09	Note2
28	D10	I	Data 10	Note2
29	D11	I	Data 11	Note2
30	D12	I	Data 12	Note2
31	D13	I	Data 13	Note2
32	D14	I	Data 14	Note2
33	D15	I	Data 15	Note2
34	D16	I	Data 16	Note2
35	D17	I	Data 17	Note2
36	D18	I	Data 18	Note2
37	D19	I	Data 19	Note2
38	D20	I	Data 20	Note2
39	D21	I	Data 21	Note2
40	D22	I	Data 22	Note2
41	D23	I	Data 23	Note2
42	IHS	I	Horizontal synchronous signal	
43	IVS	I	Vertical synchronous signal	
44	CLK	I	Data clock	
45	AV _{DD}	P	Analog power supply(+5V)	
46	AV _{DD}	P	Analog power supply(+5V)	
47	V _{CC}	P	Digital power supply(+3.3V)	
48	V _{CC}	P	Digital power supply(+3.3V)	
49	NC	-	No connect	

50	V _{GL}	I	Negative power for scan driver	
51	V _{GL}	I	Negative power for scan driver	
52	NC	-	No connect	
53	V _{GH}	I	Positive power for scan driver	
54	NC	-	No connect	
55	NC	-	No connect	
56	V _{COM}	I	V _{COM} input	
57	V _{COM}	I	V _{COM} input	
58	DEN	I	Data enabling signal	
59	GND	P	Ground	
60	GND	P	Ground	

Note1: P - Power

I - Input

O -Output

Note 2 :

Mode	D[23:16]	D[15:8]	D[7:0]	IHS	IVS	DEN
ITU-R BT 656	D[23:16]	GND	GND	NC	NC	NC
ITU-R BT 601	D[23:16]	GND	GND	IHS	IVS	NC
8 bit RGB	D[23:16]	GND	GND	IHS	IVS	NC for HV Mode
						DEN for DEN Mode
24 bit RGB	R[7:0]	G[7:0]	B[7:0]	IHS	IVS	NC for HV Mode
						DEN for DEN Mode

3. Operation Specifications

3.1. Absolute Maximum Rating

(GND =0V, Note 1)

Item	Symbol	Values		Unit	Remark
		Min.	Max.		
Power voltage	V_{CC}	-0.3	7	V	
	AV_{DD}	-0.3	7	V	
	V_{GH}	-0.3	18	V	
	V_{GL}	-15	0.3	V	
	$V_{GH}-V_{GL}$	-	33	V	
Operation Temperature	T_{OP}	-30	85	°C	
Storage Temperature	T_{ST}	-30	85	°C	

Note 1: Device is subject to be damaged permanently if stresses beyond those absolute maximum ratings listed above.

3.2. Power Sequence

3.2.1 Power on:

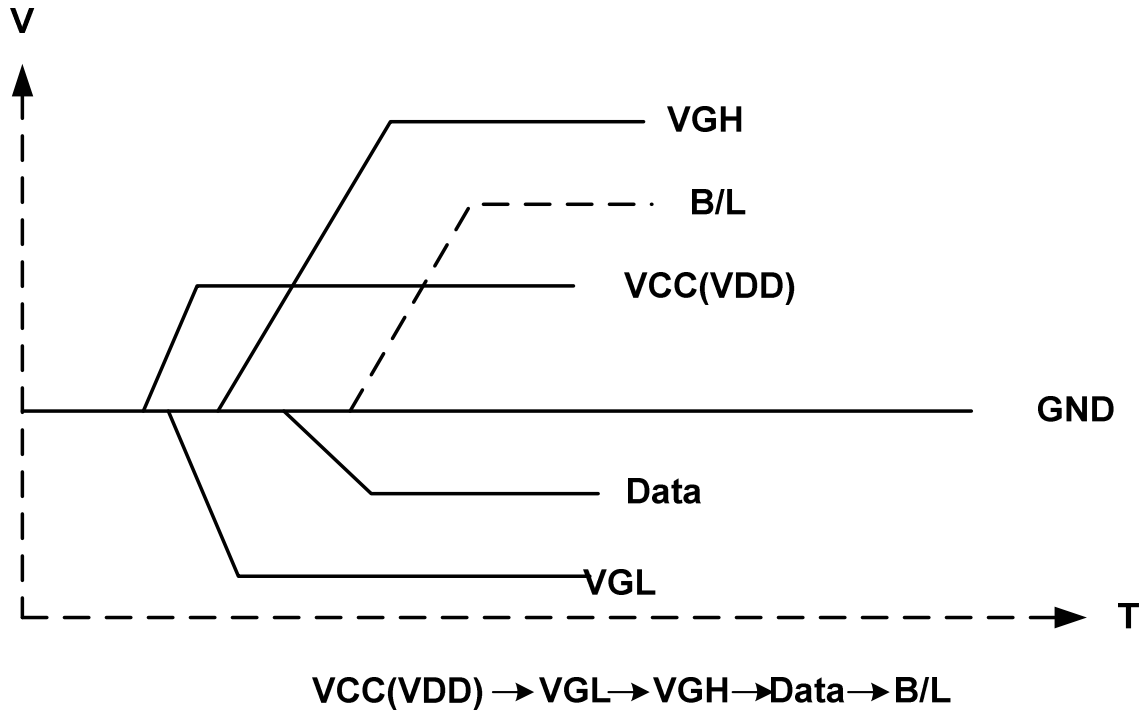

3.2.2 Power off:

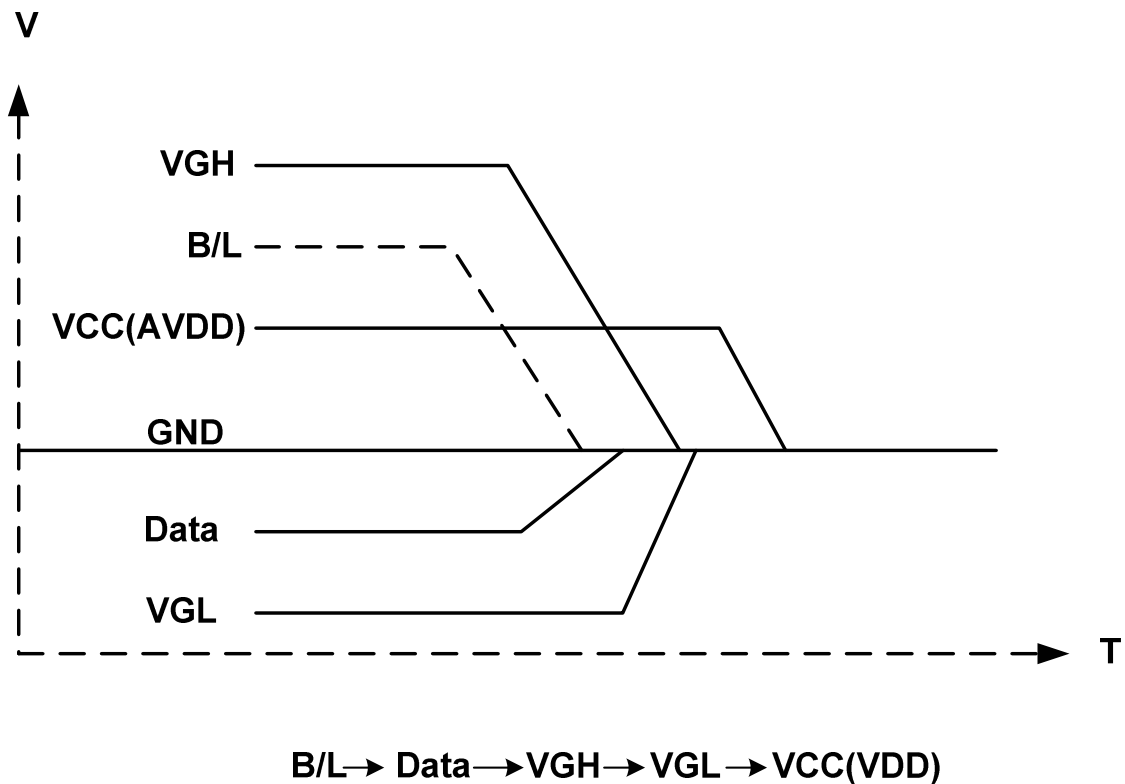

3.3. Electrical Characteristics

3.3.1. Typical Operation Conditions

(GND =0V, Note 2)

Item	Symbol	Values			Unit	Remark
		Min.	Typ.	Max.		
Power voltage	V_{CC}	3.0	3.3	3.6	V	
	AV_{DD}	4.8	5.0	5.2	V	
	V_{GH}	14.3	15	15.7	V	
	V_{GL}	-10.5	-10	-9.5	V	
V_{COM}	V_{CAC}	-	5.0	-	V	Note 1
	V_{CDC}	1.29	1.49	1.69	V	
Input logic high voltage	V_{IH}	$0.7V_{CC}$	-	V_{CC}	V	
Input logic low voltage	V_{IL}	0	-	$0.3V_{CC}$	V	

Note 1: The brightness of LCD panel could be changed by adjusting the AC component of V_{COM} .

Note 2: Be sure to apply GND, V_{CC} , and V_{GL} , to the LCD first, and then apply V_{GH} .

3.3.2. Current Consumption

(GND =0V)

Item	Symbol	Values			Unit	Remark
		Min.	Typ.	Max.		
Current for Driver	I_{GH}	-	100	300	uA	$V_{GH} = +15V$
	I_{GL}	-	-100	-300	uA	$V_{GL} = -10V$
	I_{CC}	-	1.3	5	mA	$V_{CC} = 3.3V$
	I_{DD}	-	2	5	mA	$AV_{DD} = 5V$

3.3.3. Backlight Driving Condition

Item	Symbol	Values			Unit	Remark
		Min.	Typ.	Max.		
LED voltage	V_L	-	19.8	-	V	Note 1
LED current	I_L	-	20	-	mA	Note 1
LED life time	-	20,000	-	-	Hr	Note 2

Note 1: The LED driving condition is defined for each LED module. (See the figure)

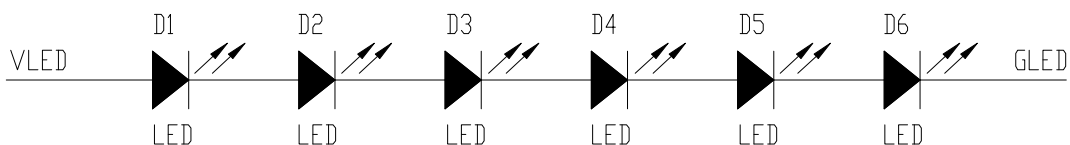

Note 2: The “LED life time” is defined as the module brightness decrease to 50% original brightness that the ambient temperature is 25°C and $I_L = 20mA$.

3.4. Timing Characteristics

3.4.1. AC Electrical Characteristics

3.3.1.1 AC Electrical Characteristics(VCC=3.3V,AVDD=5.0V, GND=AGND=0V,TA=25°C)

Item	Symbol	Values			Unit.	Remark
		Min.	Typ.	Max.		
System Operation Timing						
VDD power on slew time	T _{POR}			1000	us	From 0V to 90% VDD
Input Output Timing						
CLKIN clock time	T _{clk}	-		37	ns	
HSD to CLKIN	T _{hc}	-	-	1	T _{clk}	
HSD width	T _{hwh}	1	-	-	T _{clk}	
VSD width	T _{vwh}	1	-	-	Th	
HSD period time	Th	60	63.56	67	us	
VSD setup time	T _{vst}	12	-	-	ns	
VSD hold time	T _{vhd}	12	-	-	ns	
HSD setup time	T _{hst}	12	-	-	ns	
Data set-up time	T _{dsu}	12	-	-	ns	DIN[7:0] to CLKIN
Data hold time	T _{dhd}	12	-	-	ns	DIN[7:0] to CLKIN
DEN setup time	T _{esd}	12	-	-	ns	DEN to CLKIN
VCOMOUT output stable time	T _{cst}	-	4	8	us	96% final, CLcom=33nF, RLcom=100ohm

3.3.1.2 Timing Table
ITU-R BT 601 Mode A/B*(Note 1)

ITEM	Symbol	Value			Unit	Remark
		Min.	Typ.	Max.		
CLKIN frequency	Fclk	-	24.54/27	30	Mhz	VCC=3.3V
CLKIN cycle time	Tclk	-	40/37	-	ns	
CLKIN pulse duty	Tcwh	40	50	60	%	Tclk

ITU-R BT 656 Mode A/B*(Note 1)

ITEM	Symbol	Value			Unit	Remark
		Min.	Typ.	Max.		
CLKIN frequency	Fclk	-	27	30	Mhz	VCC=3.3V
CLKIN cycle time	Tclk	-	37	-	ns	
CLKIN pulse duty	Tcwh	40	50	60	%	Tclk

8 bit RGB 960x240 Mode

ITEM	Symbol	Value			Unit	Remark
		Min.	Typ.	Max.		
CLKIN frequency	Fclk	-	27	30	Mhz	VCC=3.3V
CLKIN cycle time	Tclk	-	37	-	ns	
CLKIN pulse duty	Tcwh	40	50	60	%	Tclk

Note 1: YUV mode A: Data sequence are "Cb-Y-Cr-Y..."

YUV mode B: Data sequence are "Cr-Y-Cb-Y..."

24 Bit RGB 960 CH Mode (320(RGB) x 240)

Item	Symbol	Values			Unit.	Remark
		Min.	Typ.	Max.		
CLKIN frequency	F _{clk}	-	-	27	Mhz	VDD=3.0~3.6V
CLKIN cycle time	T _{clk}	-	-	37	ns	
CLKIN pulse duty	T _{cwh}	40	50	60	%	T _{clk}
Time from HSD to STV	T _{hstv}	-	3	-	Tclk	
Time from HSD to LD	T _{hld}	-	24	-	Tclk	
Time from HSD to CKV	T _{hckv}	-	20	-	Tclk	
Time from HSD to OEV	T _{hoev}	-	10	-	Tclk	
Time from HSD to VCOMOUT	T _{hvcm}	-	40	-	Tclk	LD falling
Time from HSD to DATSEQ	T _{hseq}	-	20	-	Tclk	
LD pulse width	T _{wld}	-	16	-	Tclk	
CKV pulse width	T _{wckv}	-	40	-	Tclk	
OEV pulse width	T _{woev}	-	40	-	Tclk	
Time that HSD to 1'st data input	T _{hs}	24	70	255	Tclk	DDLY=70, offset=0(fixed)

3.3.1.3 3-wire serial communication AC timing

Item	Symbol	Values			Unit.	Remark
		Min.	Typ.	Max.		
Serial Clock Period Time	Tspck	320	-	-	ns	
SPCK pulse duty cycle	Tscdut	40	50	60	%	
Serial data setup time	Tisu	120	-	-	ns	
Serial data hold time	Tihd	120	-	-	ns	
Serial clock high/low	Tssw	120	-	-	ns	
SPENA select distinguish	Tcd	1	-	-	us	

3.4.2. Timing Diagram

Input Data Timing

1. Clock and Data Input Timing Diagram

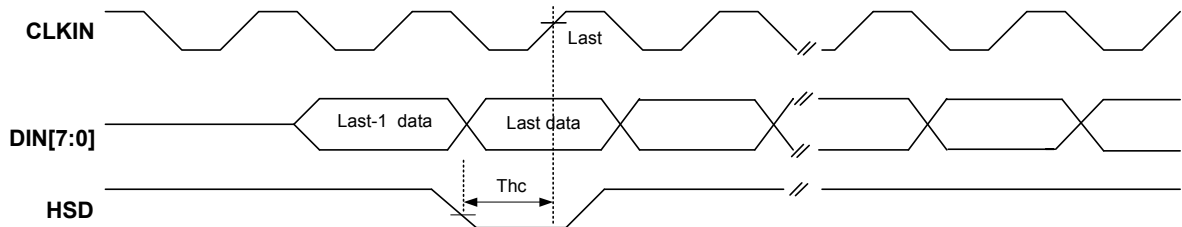
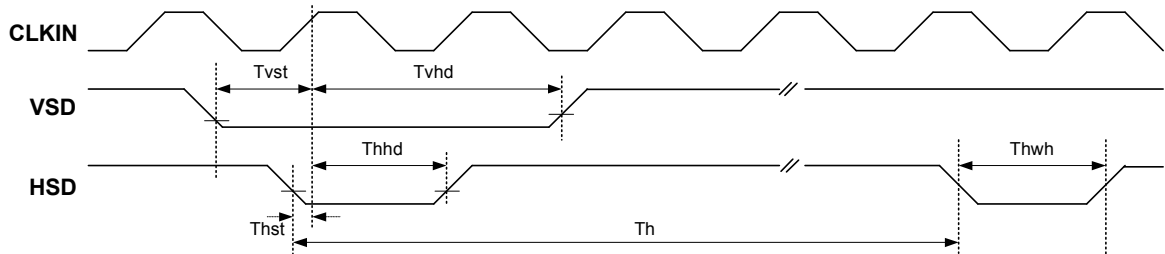
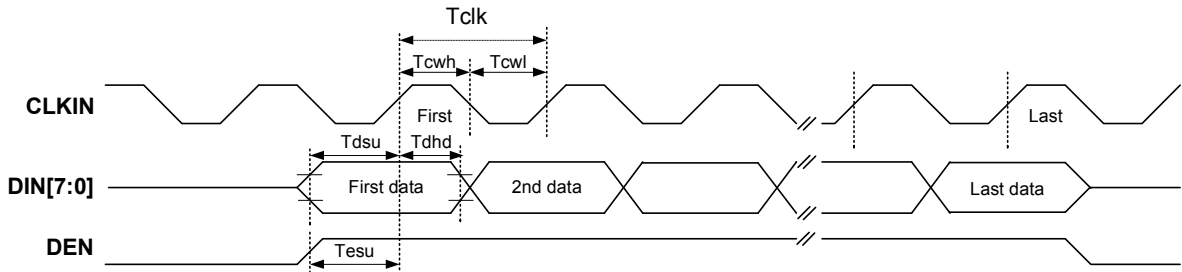

2. 8 bit RGB input Data format

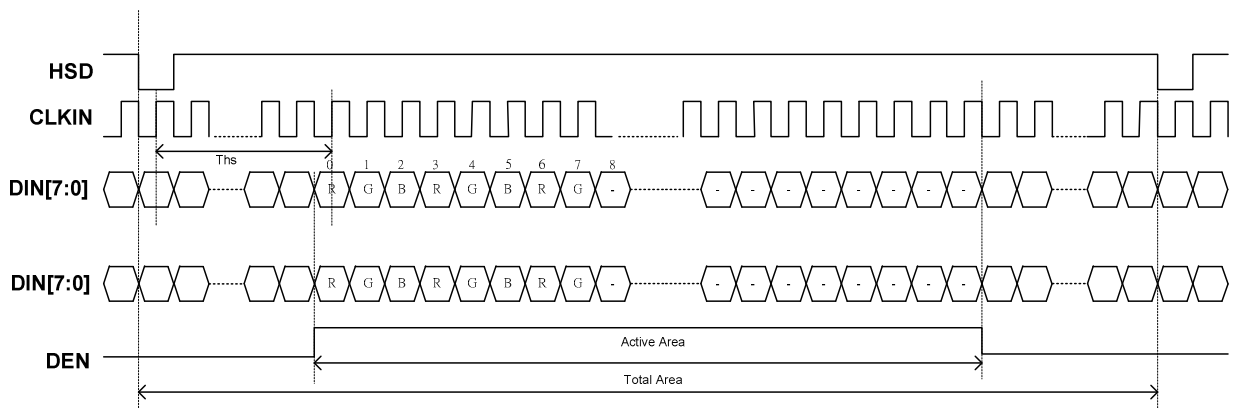

3. ITU-R BT 601

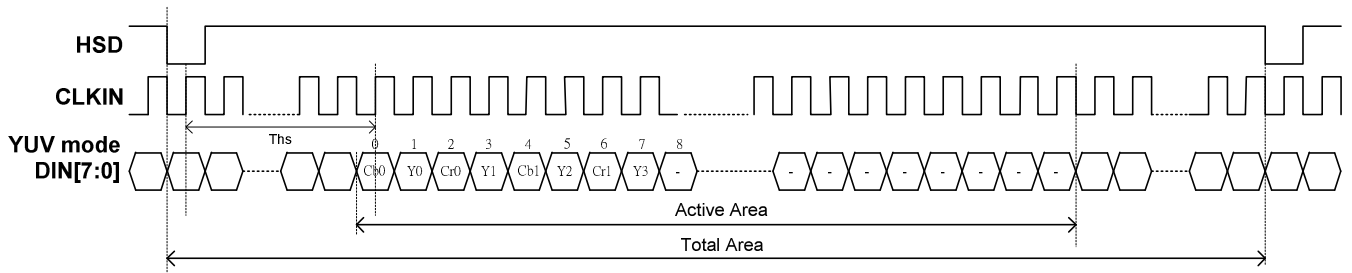

4. ITU-R BT 656

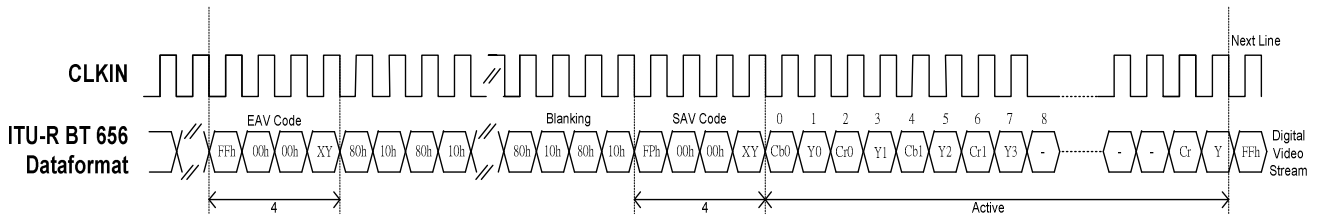

5. 24 bit RGB mode for 960 x 240

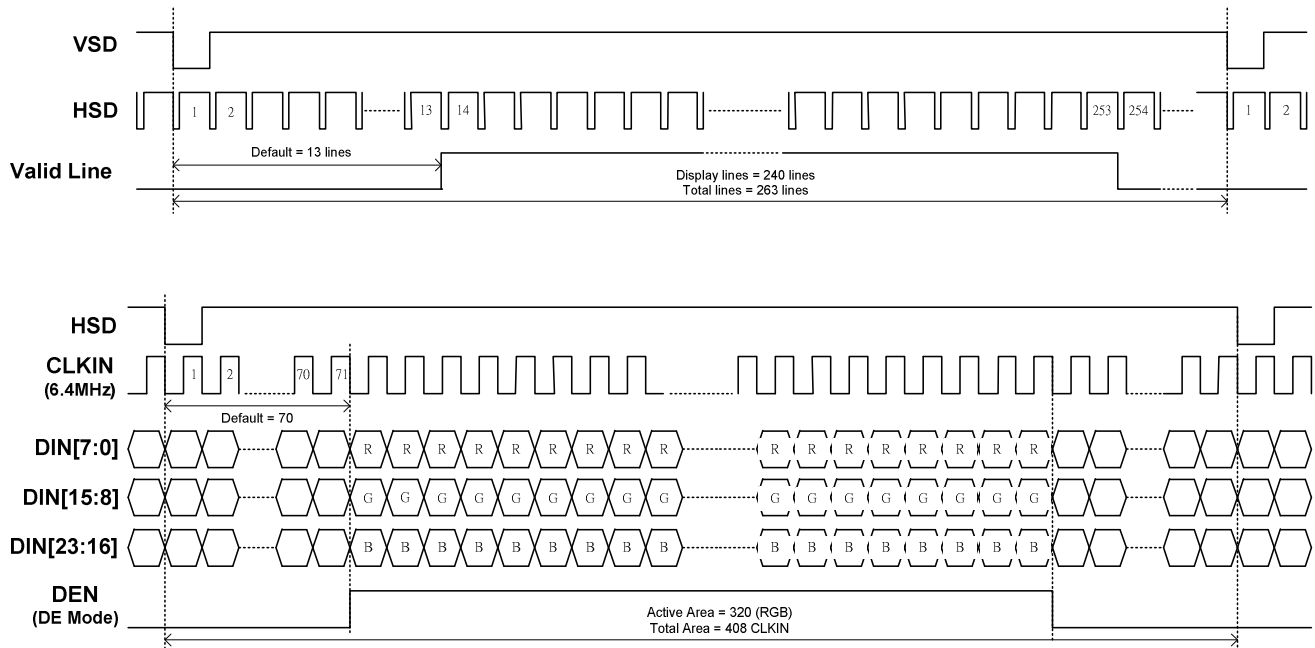

3-Wire Timing Diagram

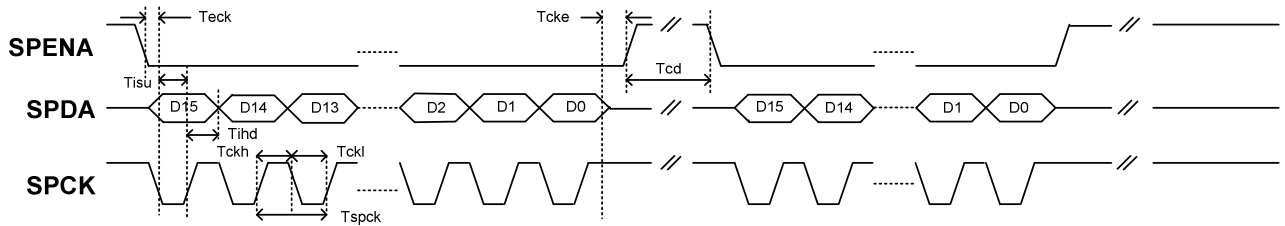

Note: 3-Wire Control Registers List

3-Wire Register		Register Description		
D[15:10]	Name	Init	R/W	Function Description
000000b	R00	(03h)	R/W	System control register
000001b	R01	(40h)	R/W	Timing controller function register
000010b	R02	(11h)	R/W	Operation control register
000011b	R03	(cch)*	R/W	Input data format control register
000100b	R04	(93h)	R/W	Source Timing delay control register
000101b	R05	(12h)	R/W	Gate Timing delay control register
000111b	R07	(03h)	R/W	Internal function control register
001000b	R08	(08h)	R/W	RGB contrast control register
001001b	R09	(40h)	R/W	RGB brightness control register
001010b	R0A	(88h)	R/W	Hue/Saturation control register
001011b	R0B	(88h)	R/W	R/B Sub-contrast control register
001100b	R0C	(20h)	R/W	R Sub-brightness control register
001101b	R0D	(20h)	R/W	B Sub-brightness control register

* Note: c4h:ITU-R BT 656 Mode
 c2h:ITU-R BT 601 Mode
 c8h:8 bit RGB Mode(HV Mode)
 c9h:8 bit RGB Mode(DE Mode)
 cch:24 bit RGB Mode (HV mode)
 cdh:24 bit RGB Mode (DE mode)

4. Optical Specifications

Item	Symbol	Condition	Min.	Typ.	Max.	Unit	Remark
Viewing angle (CR≥10)	θ_L	$\Phi=180^\circ$ (9 o'clock)	55	65	-	degree	Note 1
	θ_R	$\Phi=0^\circ$ (3 o'clock)	55	65	-		
	θ_T	$\Phi=90^\circ$ (12 o'clock)	35	45	-		
	θ_B	$\Phi=270^\circ$ (6 o'clock)	55	65	-		
Response Time	T_{ON}	Normal $\theta=\Phi=0^\circ$	-	15	30	msec	Note 3
	T_{OFF}		-	20	50	msec	Note 3
Contrast ratio	CR		200	300	-	-	Note 4
Color chromaticity	W_X		-	(0.33)	-	-	Note 5
	W_Y		-	(0.36)	-	-	Note 6
Luminance	L		300	350	-	cd/m ²	Note 6
Luminance uniformity	Y_U		70	75	-	%	Note 7

Test Conditions:

- $V_{CC}=3.3V$, $AV_{DD}=5.0V$, $I_L=20mA$ (Backlight current), the ambient temperature is $25^\circ C$.
- The test systems refer to Note 2.

Note 1: Definition of viewing angle range

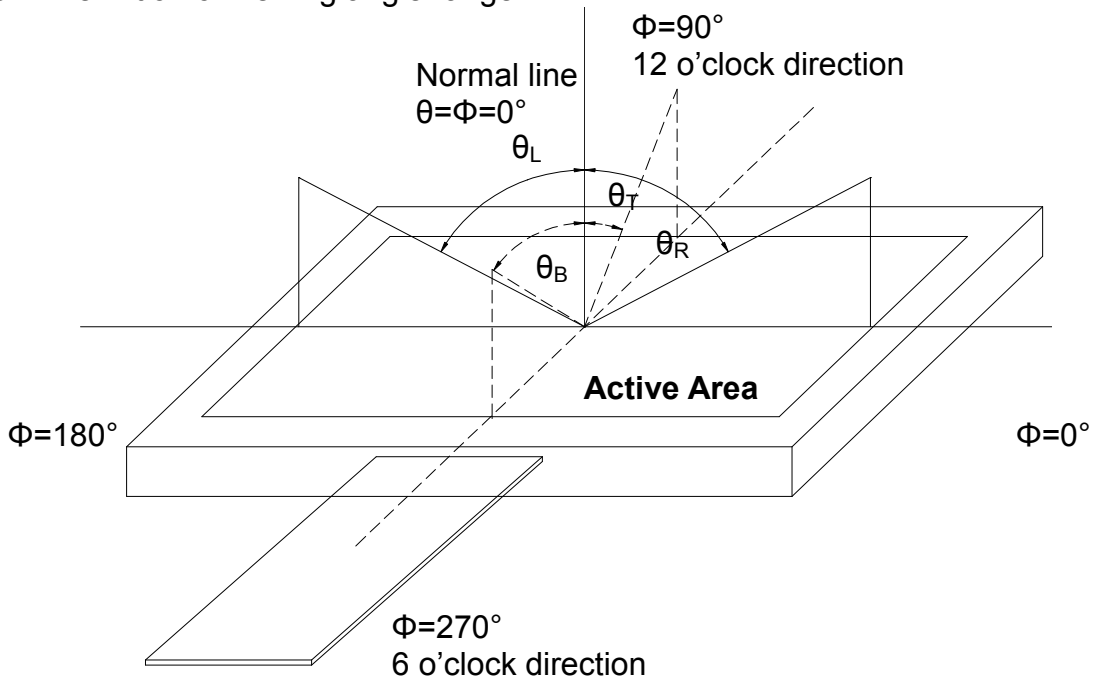

Fig. 5-1 Definition of viewing angle

Note 2: Definition of optical measurement system.

The optical characteristics should be measured in dark room. The optical properties are measured at the center point of the LCD screen. (Response time is measured by Photo detector TOPCON BM-7, other items are measured by BM-5A/Field of view: 1° /Height: 500mm.)

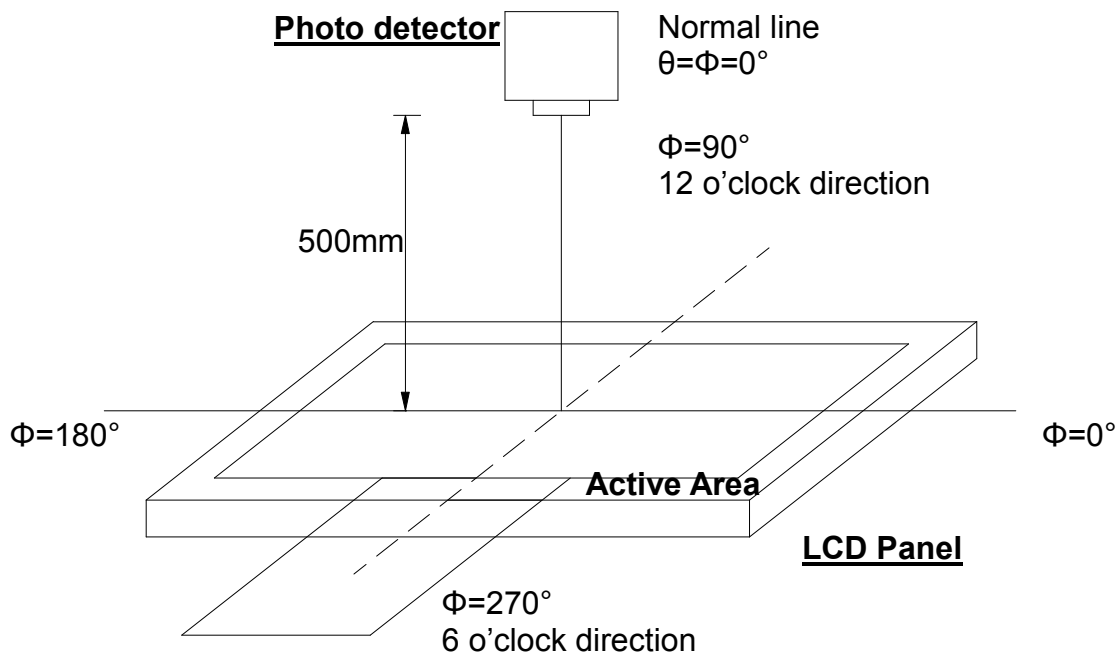

Fig. 5-2 Optical measurement system setup

Note 3: Definition of Response time

The response time is defined as the LCD optical switching time interval between "White" state and "Black" state. Rise time (T_{ON}) is the time between photo detector output intensity changed from 90% to 10%. And fall time (T_{OFF}) is the time between photo detector output intensity changed from 10% to 90%.

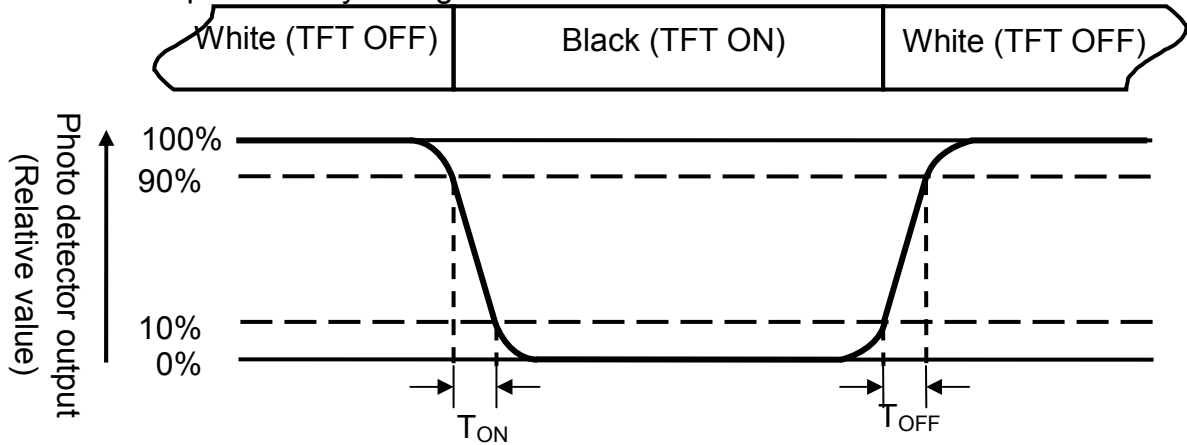

Fig. 5-3 Definition of response time

Note 4: Definition of contrast ratio

$$\text{Contrast ratio (CR)} = \frac{\text{Luminance measured when LCD is on the "White" state}}{\text{Luminance measured when LCD is on the "Black" state}}$$

Note 5: Definition of color chromaticity (CIE1931)

Color coordinates measured at center point of LCD.

Note 6: All input terminals LCD panel must be ground when measuring the center area of the panel.

Note 7: Definition of Luminance Uniformity

To test for uniformity, the tested area, which is inside the active area, is divided into 3 rows and 3 columns. The measurement spot is placed at the center of each box.

$$\text{Luminance Uniformity (Yu)} = \frac{B_{min}}{B_{max}}$$

L-----Active area length W----- Active area width

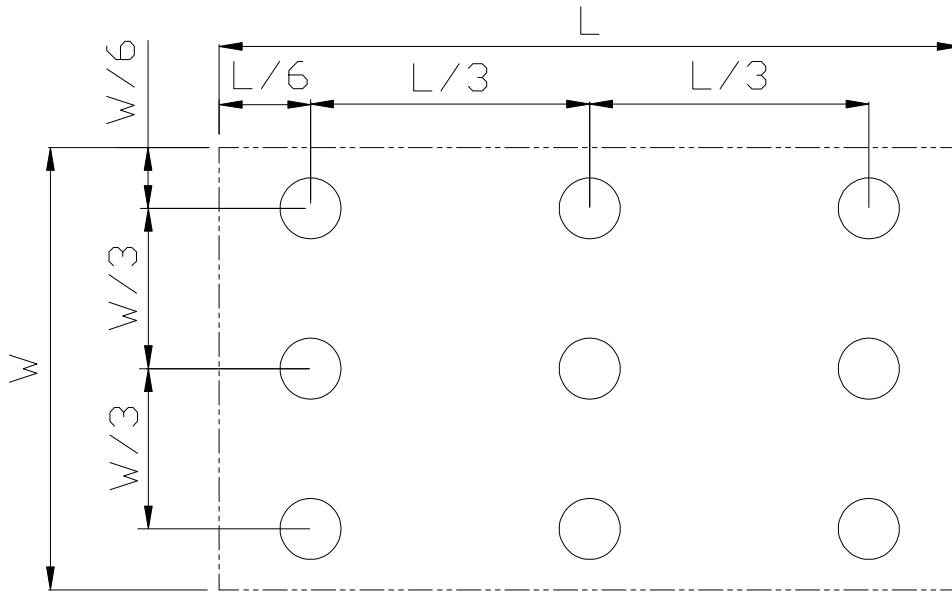

Fig. 5-4 Definition of uniformity

B_{max}: The measured maximum luminance of all measurement position.

B_{min}: The measured minimum luminance of all measurement position.

5. Reliability Test Items

Item	Test Conditions	Remark
High Temperature Storage	Ta = 85°C 240 hrs	Note 1
Low Temperature Storage	Ta = -30°C 240hrs	Note 1
High Temperature Operation	Ts = 85°C 240hrs	Note 2
Low Temperature Operation	Ta = -30°C 240hrs	Note 1
Operate at High Temperature and Humidity	+60°C, 90%RH max. 240 hrs	
Thermal Shock	-30°C/30 min ~ +85°C/30 min for a total 100 cycles, Start with cold temperature and end with high temperature	
Vibration Test	Frequency range:10~55Hz Stroke:1.5mm Sweep:10Hz~55Hz~10Hz 2 hours for each direction of X. Y. Z. (6 hours for total)	
Mechanical Shock	100G 6ms,±X, ±Y, ±Z 3 times for each direction	
Package Vibration Test	Random Vibration : 0.015G*G/Hz from 5-200HZ, -6dB/Octave from 200-500HZ 2 hours for each direction of X. Y. Z. (6 hours for total)	
Package Drop Test	Height:60 cm 1 corner, 3 edges, 6 surfaces	
Electro Static Discharge	± 2KV, Human Body Mode, 100pF/1500Ω	

Note 1: Ta is the ambient temperature of samples.

Note 2: Ts is the temperature of panel's surface.

Note 3: In the standard condition, there shall be no practical problem that may affect the display function.

6. Handling Precautions

6.1. Safety

Liquid crystal is poisonous. Do not put it in your mouth. If liquid crystal touches your skin or clothes, wash it off immediately by using soap and water.

6.2. Handling

1. The LCD panel is plate glass. Do not subject the panel to mechanical shock or to excessive force on its surface.
2. The polarizer attached to the display is easily damaged. Please handle it carefully to avoid scratch or other damages.
3. To avoid contamination on the display surface, do not touch the module surface with bare hands.
4. Keep a space so that the LCD panels do not touch other components.
5. Put cover board such as acrylic board on the surface of LCD panel to protect panel from damages.
6. Transparent electrodes may be disconnected if you use the LCD panel under environmental conditions where the condensation of dew occurs.
7. Do not leave module in direct sunlight to avoid malfunction of the ICs.

6.3. Static Electricity

1. Be sure to ground module before turning on power or operating module.
2. Do not apply voltage which exceeds the absolute maximum rating value.

6.4. Storage

1. Store the module in a dark room where must keep at $+25\pm 10^{\circ}\text{C}$ and 65%RH or less.
2. Do not store the module in surroundings containing organic solvent or corrosive gas.
3. Store the module in an anti-electrostatic container or bag.

6.5. Cleaning

1. Do not wipe the polarizer with dry cloth. It might cause scratch.
2. Only use a soft sloth with IPA to wipe the polarizer, other chemicals might permanent damage to the polarizer.

7. Mechanical Drawing

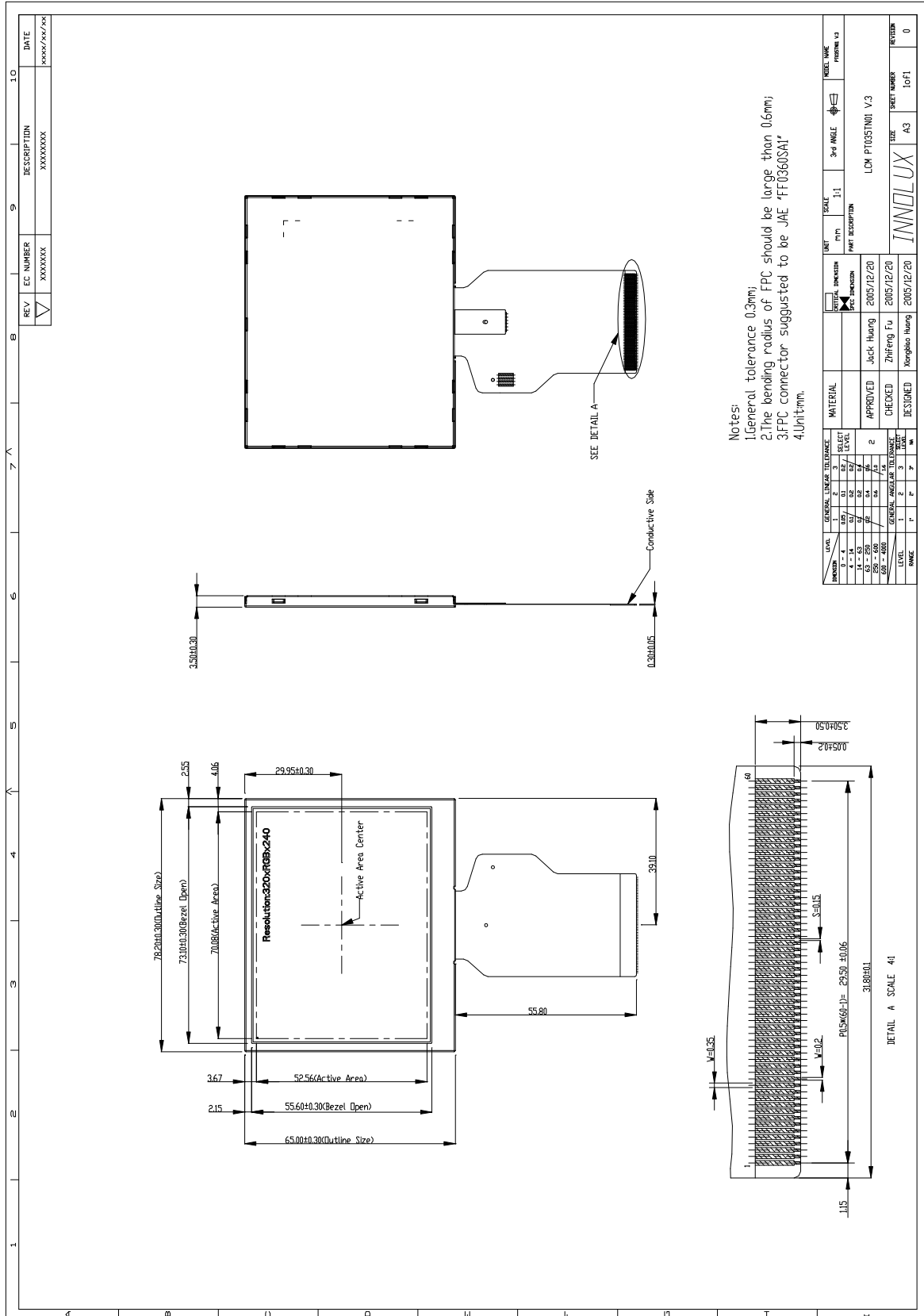

8. Package Drawing

8.1. Packaging Material Table

No	Item	Model (Material)	Dimensions(mm)	Unit Weight(Kg)	Quantity (pcs)	Remark
1	LCM module	PT035TN01 V.3	78.2 ×65.0 ×3.5	0.0352	260	
2	Corrugated Board-1	BC Corrugated Paper	510×343	0.130	2	
3	Corrugated Board-2	B Corrugated Paper	1152×512	0.26	1	
4	Corrugated Bar	B Corrugated Paper	343×104	0.020	12	
5	Partition	BC Corrugated Paper	512×343×106	1.045	2	
6	Dust-Proof Bag	PE	700×530	0.0604	1	
7	A/S Bag	PE	112×90	1.1108 ×10 ⁻³	260	
8	Carton	Corrugated Paper	530×355×255	1.1	1	
g	Total weight	13.5± 5% Kg				

8.2. Packaging Quantity

(1) LCM quantity per Partition:	2 row x 21 pcs + 4 row x 22 pcs = 130 pcs
(2) Total LCM quantity in Carton:	2 layer x 130 pcs per Partition = 260 pcs

8.3. Packaging Drawing

