

OPTIMUS® Color Pocket TFT LCD TV Cat. No. 16-182

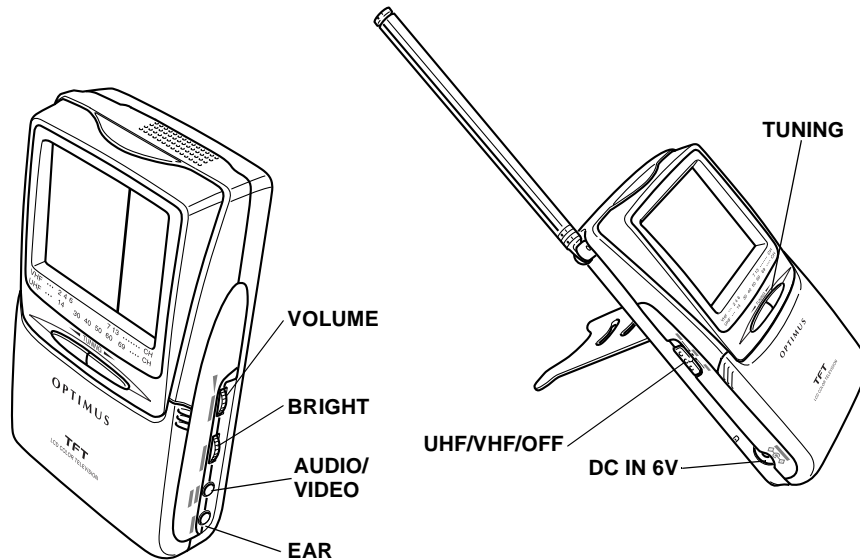

Features

Your Optimus Color Pocket LCD TV is portable and fits in the palm of your hand. Even though the TV is small, it is packed with great features:

2.5-Inch TFT (Active Matrix) Flat Liquid Crystal Display — makes the TV more compact and uses less power than a standard picture tube.

Automatic Electronic Tuning System — scans the VHF or UHF band and locks on to active channels.

Three Power Options — lets you power the TV using internal batteries (not supplied) or an optional AC or DC adapter (not supplied).

Earphone Jack — lets you enjoy private listening with an optional earphone.

Audio/Video Jack — lets you connect a camcorder, VCR, laser disc player, or any other device that has A/V outputs.

Fluorescent Backlight — illuminates the LCD screen so you can watch the TV in the dark or in low-light conditions.

Built-In Rod Antenna — provides adequate reception in most metropolitan areas.

Important: An external antenna jack is not available on this TV. Do not attempt to connect an external antenna.

© 1999 Tandy Corporation.
All Rights Reserved.

Optimus and RadioShack are registered trademarks used by Tandy Corporation.

Power

USING BATTERIES

Your TV uses three AA batteries (not supplied) for power. For the best results, we recommend RadioShack alkaline batteries.

Cautions:

- Use only fresh batteries of the required size and recommended type.
 - Do not mix old and new batteries, different types of batteries (standard, alkaline, or rechargeable), or rechargeable batteries of different capacities.
1. Slide off the battery compartment's cover (on the front of the TV) in the direction of the arrow, and remove the it.

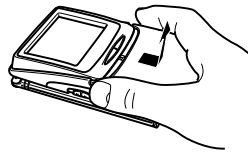

2. Insert three fresh batteries, aligning the positive (+) poles with the positive polarity symbols (+) marked inside.

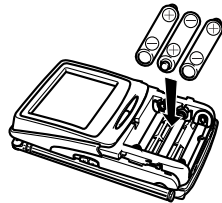

Caution: Installing batteries incorrectly can damage the TV.

3. Replace the cover.

Notes:

- The TV can operate for about 3 hours with alkaline batteries. When the sound level lowers or the picture becomes unstable, replace the batteries.

- Internal batteries automatically disconnect when you connect an adapter to the **DC IN 6V** jack.

Warning: Dispose of old batteries promptly and properly. Do not burn or bury them.

Caution: Always remove old or weak batteries. Batteries can leak chemicals that can destroy electronic parts.

AC POWER

You can power the TV from a standard AC outlet using an optional AC adapter available at your local RadioShack store.



Caution: You must use an optional Class 2 power source that supplies 6 volts AC and delivers at least 550 mA. Its center tip must be set to positive and its plug must fit the TV's **DC IN 6V** jack. Using an adapter that does not meet these specifications could damage the TV or the adapter.

Set the adapter's voltage switch to 6V. Attach the adapter's 4 mm outer diameter/1.7 mm inner diameter barrel plug, aligning + with TIP, and plug it into the TV's **DC IN 6V** jack. Plug the other end of the adapter into a standard AC outlet.

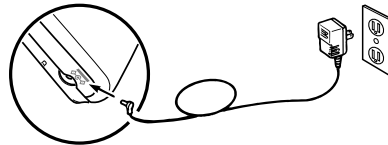

Cautions:

- Do not leave the adapter plugged into the AC outlet or connected to the TV when you are not using the TV.
- Always unplug the adapter from the AC outlet first.
- It is normal for the adapter to become warm after extended periods of use.

VEHICLE BATTERY POWER

You can use an optional DC adapter to power the TV from a vehicle's cigarette-lighter socket if the vehicle has a 12-volt DC, negative ground electrical system. Your local RadioShack store sells a variety of adapters.



Caution: You must use a DC adapter that supplies 6 volts and delivers at least 550 mA. Its center tip must be set to positive,

and its plug must correctly fit the TV's **DC IN 6V** jack. Using an adapter that does not meet these specifications could seriously damage the TV or the adapter.

1. Set the adapter's voltage switch to 6V.
2. Attach the adapter's 4 mm outer diameter/1.7 mm inner diameter barrel plug, aligning + with TIP, and plug it into the TV's **DC IN 6V** jack.
3. Unplug the vehicle's cigarette lighter and plug the large end of the DC adapter cord into the cigarette-lighter socket.

Cautions:

- Do not leave the adapter plugged into the cigarette-lighter socket or connected to the TV when you are not using the TV.
- Always unplug the adapter from the cigarette-lighter socket first.

Note: If the TV does not operate properly when you use DC power, be sure the cigarette-lighter socket is clean and that the adapter's plug is pushed all the way into the socket.

Using Your TV

1. Extend the telescoping rod antenna.
2. Set **UHF/VHF/OFF** to **VHF** or **UHF**. The TV starts scanning and stops at the first active channel in the selected band.
3. Press **TUNING** ◀ or ▶ to tune to a different channel. The tuning line (red for VHF, green for UHF) on the screen

aligns with the channel number shown below the screen.

4. To adjust the volume, rotate **VOLUME** located on the right side of the TV.
5. To adjust the picture to the desired brightness, rotate **BRIGHT** located on the right side of the TV. The brightness also changes with the screen's angle.

Notes:

- In low temperatures, the TV screen takes a few seconds to light, or it is slightly red in color. This is not a malfunction. Normal operation resumes after a short while.
- If reception is poor, adjust the length, angle, and direction of the telescoping antenna. If inside a metal or concrete building, moving closer to a window might improve reception.
- If desired, fold out the stand on the back of the TV and lean the TV on a flat surface.

USING THE TV AS A MONITOR

You can play back the signal from an audio/video component on your TV using a Y-adaptor cable (not supplied). We recommend RadioShack Cat. No. 42-2475 available at your local RadioShack store.

Connect the cable's yellow plug to the component's video output jack and its white plug to the component's audio output jack. Then plug the cable's sub-mini plug into the TV's **AUDIO/VIDEO** jack.

Note: Connecting an audio/video component disables the TV's antenna.

USING AN EARPHONE

For private listening, you can connect an optional earphone with a 1/8-inch (3.5 mm) plug to the TV's **EAR** jack. This automatically mutes the built-in speaker.



Listening Safely

To protect your hearing, follow these guidelines when you use an earphone.

- Set the volume to the lowest setting before you begin listening. After you begin listening, adjust the volume to a comfortable level.
- Do not listen at extremely high volume levels. Extended high-volume listening can lead to permanent hearing loss.
- Once you set the volume, do not increase it. Over time, your ears adapt to the volume level, so a volume level that does not cause discomfort might still damage your hearing.

Traffic Safety

Do not wear an earphone while operating a motor vehicle or riding a bicycle. This can create a traffic hazard and could be illegal in some areas.

Even though some earphones let you hear some outside sounds when listening at normal volume levels, they still can present a traffic hazard.

Troubleshooting

Color too light or no color.

- Extend the antenna and adjust its angle and direction.
- Adjust **BRIGHT**.

No picture and no sound.

- Be sure the batteries are fresh and inserted correctly.
- Be sure the adapter is correctly connected.

No picture and fuzzy sound.

- Adjust the antenna.

Picture, but no sound.

- Adjust **VOLUME**.
- Be sure you disconnected the earphone.

Sound, but the picture is all white, dark, or blurred.

- Adjust **BRIGHT**.
- Be sure the batteries are fresh.

Picture is not clear (moves up or down, disappears periodically, becomes fuzzy or blurred, is doubled, etc.), but the TV has sound.

- Be sure the antenna is fully extended. Adjust the antenna's angle and direction for the best reception.
- Be sure the batteries are fresh.
- Be sure the TV is away from appliances that might cause interference.
- In locations with poor reception, it might be impossible to get a clear picture or any picture at all. Move the TV to a different location.

If you are unable to identify the problem, take the TV to your local RadioShack store for assistance.

This device complies with Part 15 of the *FCC Rules*. Operation is subject to the following two conditions:

- This device may not cause harmful interference.
- This device must accept any interference received, including interference that may cause undesired operation.

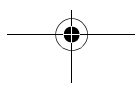
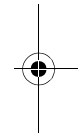
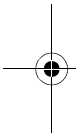

Care and Maintenance

Your Optimus Color Pocket TFT LCD TV is an example of superior design and craftsmanship. These suggestions will help you care for it so you can enjoy it for years.

- Keep the TV dry. If it gets wet, wipe it dry immediately.
- Use only fresh batteries of the required size and recommended type. Always remove old or weak batteries. They can leak chemicals that destroy electronic circuits.
- Handle the TV gently and carefully. Dropping it can damage circuit boards and cases and can cause the TV to work improperly. Be particularly careful of the display screen. Avoid putting the TV in your pocket or purse together with hard objects (coins, keys, etc.).
- Use and store the TV only in normal temperature environments.
- Keep the TV away from dust and dirt.
- Wipe the TV with a damp cloth occasionally to keep it looking new. Do not use harsh chemicals, cleaning solvents, or strong detergents to clean the TV.

Modifying or tampering with the TV's internal components can cause a malfunction and might invalidate the TV's warranty and void your FCC authorization to operate it. If the TV is not performing as it should, take it to your local RadioShack store for assistance.

Specifications

Channel Coverage	UHF: CH 14–CH 69 VHF: CH 2–CH 13
Display Element	High Resolution Color LCD (Twisted Nematic Type)
Screen Size	2 1/2 Inches Diagonally (63 mm)
Backlight	High-Luminescent Fluorescent Material
Antenna	Rod
Speaker	3/4 Inch Diagonally (20 mm)
Terminals	DC IN 6V, EAR, AUDIO/VIDEO
Power Supply	Three AA Batteries AC Adapter (DC 6V) DC Adapter (DC 6V)
Power Consumption	Approx. 3.4 Watts Maximum
Dimensions (HWD)	4 13/16 x 3 x 1 3/16 Inches (122 x 77 x 30 mm)
Weight (Without Batteries)	Approximately 6.8 oz. (190 g)

Specifications are typical; individual units might vary. Specifications are subject to change and improvement without notice.

Limited Ninety-Day Warranty

This product is warranted by RadioShack against manufacturing defects in material and workmanship under normal use for ninety (90) days from the date of purchase from RadioShack company-owned stores and authorized RadioShack franchisees and dealers. EXCEPT AS PROVIDED HEREIN, RadioShack MAKES NO EXPRESS WARRANTIES AND ANY IMPLIED WARRANTIES, INCLUDING THOSE OF MERCHANTABILITY AND FITNESS FOR A PARTICULAR PURPOSE, ARE LIMITED IN DURATION TO THE DURATION OF THE WRITTEN LIMITED WARRANTIES CONTAINED HEREIN. EXCEPT AS PROVIDED HEREIN, RadioShack SHALL HAVE NO LIABILITY OR RESPONSIBILITY TO CUSTOMER OR ANY OTHER PERSON OR ENTITY WITH RESPECT TO ANY LIABILITY, LOSS OR DAMAGE CAUSED DIRECTLY OR INDIRECTLY BY USE OR PERFORMANCE OF THE PRODUCT OR ARISING OUT OF ANY BREACH OF THIS WARRANTY, INCLUDING, BUT NOT LIMITED TO, ANY DAMAGES RESULTING FROM INCONVENIENCE, LOSS OF TIME, DATA, PROPERTY, REVENUE, OR PROFIT OR ANY INDIRECT, SPECIAL, INCIDENTAL, OR CONSEQUENTIAL DAMAGES, EVEN IF RadioShack HAS BEEN ADVISED OF THE POSSIBILITY OF SUCH DAMAGES.

Some states do not allow the limitations on how long an implied warranty lasts or the exclusion of incidental or consequential damages, so the above limitations or exclusions may not apply to you.

In the event of a product defect during the warranty period, take the product and the RadioShack sales receipt as proof of purchase date to any RadioShack store. RadioShack will, at its option, unless otherwise provided by law: (a) correct the defect by product repair without charge for parts and labor; (b) replace the product with one of the same or similar design; or (c) refund the purchase price. All replaced parts and products, and products on which a refund is made, become the property of RadioShack. New or reconditioned parts and products may be used in the performance of warranty service. Repaired or replaced parts and products are warranted for the remainder of the original warranty period. You will be charged for repair or replacement of the product made after the expiration of the warranty period.

This warranty does not cover: (a) damage or failure caused by or attributable to acts of God, abuse, accident, misuse, improper or abnormal usage, failure to follow instructions, improper installation or maintenance, alteration, lightning or other incidence of excess voltage or current; (b) any repairs other than those provided by a RadioShack Authorized Service Facility; (c) consumables such as fuses or batteries; (d) cosmetic damage; (e) transportation, shipping or insurance costs; or (f) costs of product removal, installation, set-up service adjustment or reinstallation.

This warranty gives you specific legal rights, and you may also have other rights which vary from state to state.

RadioShack Customer Relations,
200 Taylor Street, 6th Floor, Fort Worth, TX 76102

We Service What We Sell

04/99

RadioShack
A Division of Tandy Corporation
Fort Worth, Texas 76102

MA9706-A
06A99

K0041-07-01
Printed in Malaysia